

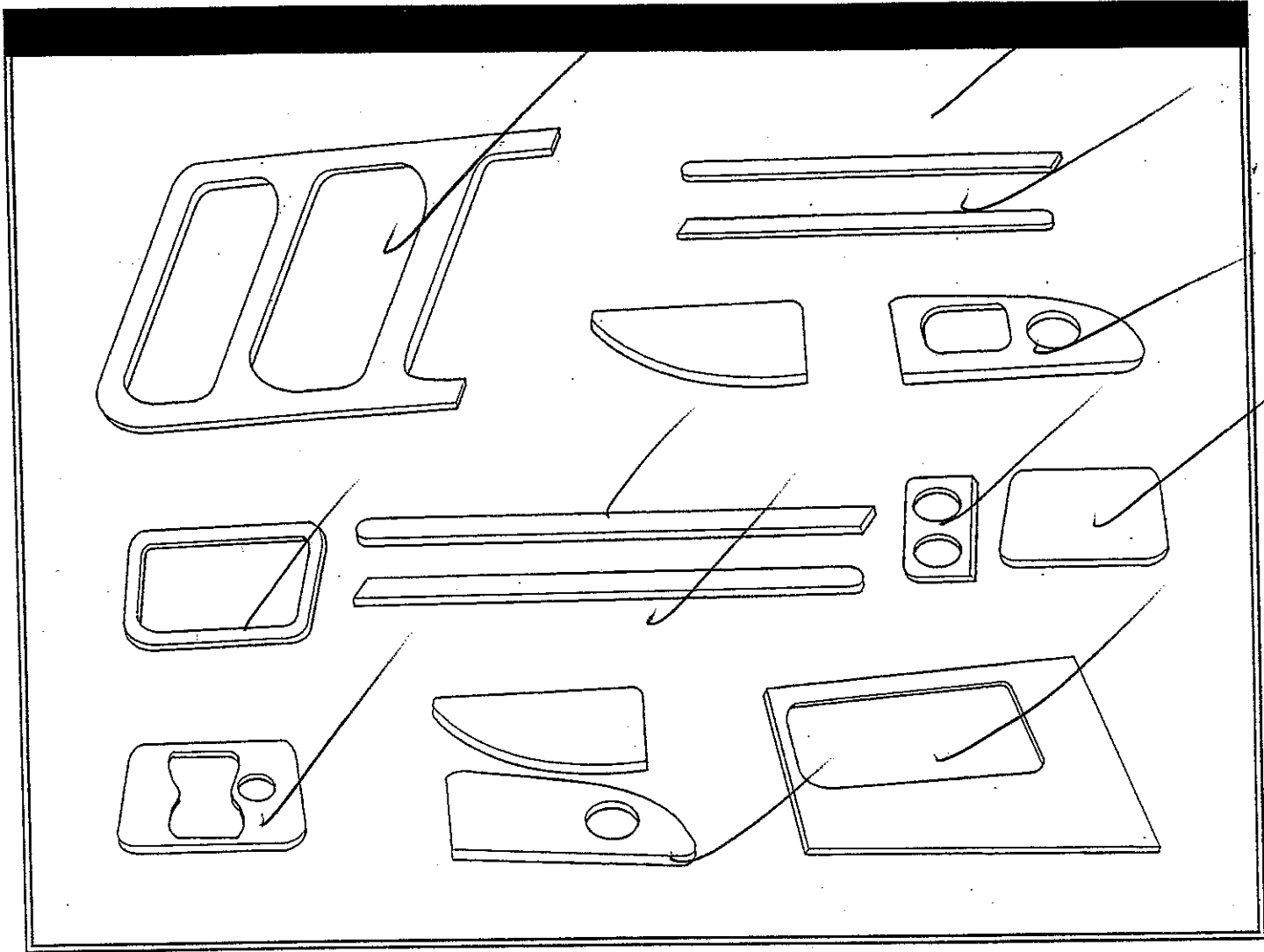

Mopar

PARTS



GB

INSTALLATION INSTRUCTION - DASH KIT - WOOD ACCENT TRIM

E

INSTRUCCIONES DE MONTAJE - JUEGO DE TABLERO - ADORNOS DE MADERA

F

NOTICE DE MONTAGE - KIT DE TABLEAU DE BORD - CARNISSAGE BOIS

Subject to alteration without notice
Reservadas modificaciones técnicas
Sous réserve de modifications techniques

Expert Fitting Required
Montaje solo por el concesionario
Montage par spécialiste nécessaire

01-92-411 K6858460

DAIMLER CHRYSLER

GB

APPLICATION: JEEP LIBERTY (KJ) 2002

- Clean areas to be covered with interior trim using 3M S70 wax & grease remover (or equivalent).
- Clean areas to be covered with interior trim using Isopropyl Alcohol.
- When cleaning, constantly use a new section of towel as you move from area to area.
- **WARNING:** Cleaning solvents may cause discoloration to vinyl. Be careful to clean only those area which will be covered by interior trim kit.

IMPORTANT NOTICE

Prior to installation check the entire kit for possible damage or defects. If damage is found, contact Vendor for a replacement. **DO NOT INSTALL ANY PARTS. YOU MUST RETURN THE COMPLETE KIT IF YOU WISH TO MAKE A WARRANTY CLAIM.**

E

APLICACIÓN: JEEP LIBERTY (KJ) 2002

- Limpie las áreas que quedarán cubiertas por los adornos utilizando cera 3M S70 y limpiador de grasa (o equivalente).
- Limpie con alcohol isopropílico las áreas que quedarán cubiertas por los adornos.
- Al limpiar las distintas áreas, cambie constantemente la zona del paño utilizado.
- **ADVERTENCIA:** Los disolventes de limpieza pueden causar la decoloración del vinilo. Tenga la precaución de limpiar sólo las áreas que quedarán cubiertas por el juego de adornos.

AVISO IMPORTANTE

Antes de la instalación, revise todo el juego para descartar posibles daños o defectos. Si se encontrara daño alguno, póngase en contacto con su proveedor para obtener un reemplazo. **NO INSTALE NINGUNA PIEZA. SI DESEA HACER USO DE LA GARANTÍA, DEBERÁ DEVOLVER EL JUEGO COMPLETO.**

F

APPLICATION : JEEP LIBERTY (KJ) 2002

- Nettoyer les surfaces à couvrir de garnissage intérieur avec le décapant pour cire et graisse 3M S70 (ou un produit équivalent).
- Nettoyer les surfaces à couvrir de garnissage intérieur avec de l'alcool isopropylique.
- Toujours utiliser une nouvelle section propre du chiffon pou nettoyer un nouvel endroit.
- **AVERTISSEMENT :** Les solvants de nettoyage peuvent décolorer le vinyle. Veiller à ne nettoyer que les endroits à couvrir avec le garnissage intérieur.

REMARQUE IMPORTANTE

Avant de l'installer, vérifier l'ensemble du kit pour s'assurer qu'il ne présente ni dommages, ni défauts. En cas de dommage, contacter le fournisseur pour obtenir un kit de remplacement. **N'INSTALLER AUCUNE PIÈCE. LE KIT DOIT ÊTRE RETOURNÉ AU COMPLET POUR TOUTE RÉCLAMATION EN GARANTIE.**

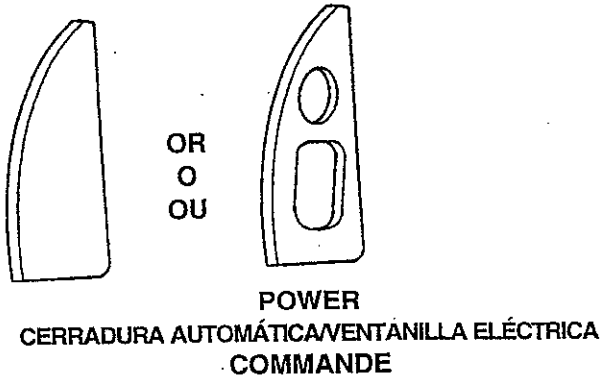

A LH IZQ. CÔTÉ GAUCHE

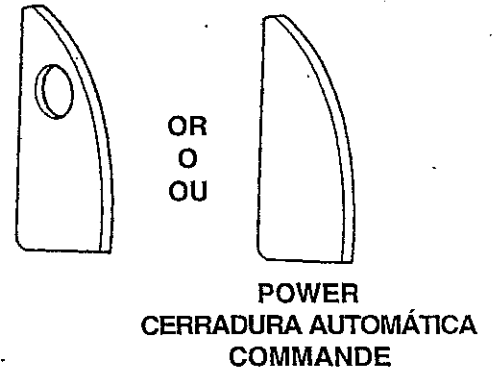

B RH DER. CÔTÉ DROIT

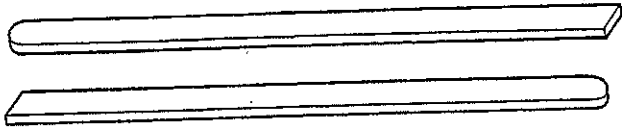

C LH / RH IZQ./DER. CÔTÉ GAUCHE/DROIT

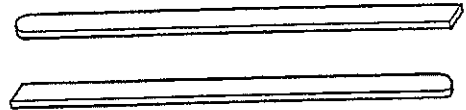

D LH / RH IZQ./DER. CÔTÉ GAUCHE/DROIT

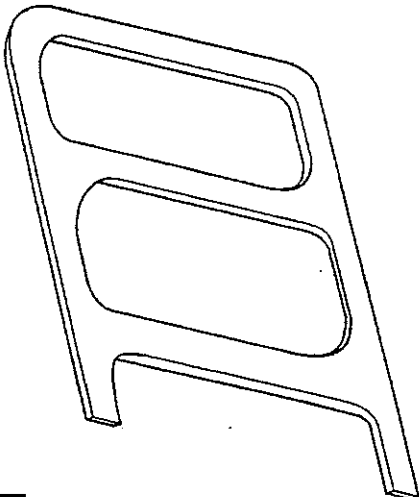

E



F

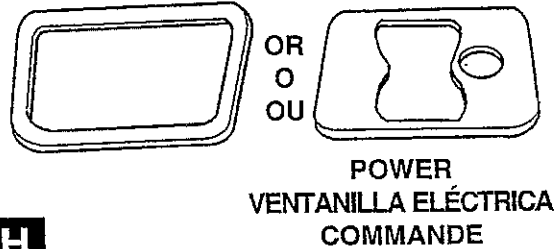

H



G

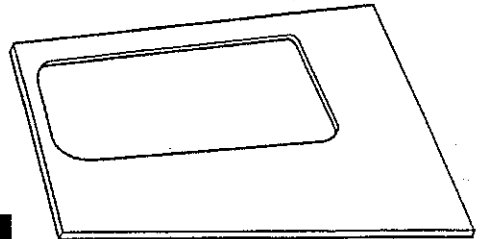

I

